

RoHS compliant

FEATURES

- Excellent high frequency characteristics (to 2.6GHz)

Type	Frequency	900MHz	2.6GHz
Impedance 50Ω	V.S.W.R. (Max.)	1.3	1.7
	Insertion loss (dB, Max.)	0.2	0.7
	Isolation (dB, Min.)	60	30
Impedance 75Ω	V.S.W.R. (Max.)	1.2	1.5
	Insertion loss (dB, Max.)	0.2	0.5
	Isolation (dB, Min.)	60	30

- Surface-mount type also available
- Compact and slim size

Size: 20.2(L) × 11.2(W) × 8.9(H)* mm
 .795(L) × .441(W) × .350(H) inch

*The height of Surface-mount type is 9.6 mm .378 inch size.

TYPICAL APPLICATIONS

- 1. Broadcasting and video markets.**
 - Digital broadcasting market
 - STB/tuner market, etc.
- 2. Communications market**
 - Antennae switching
 - All types of wireless devices

If you wish to use in applications with low level loads or with high frequency switching, please consult us.

ORDERING INFORMATION

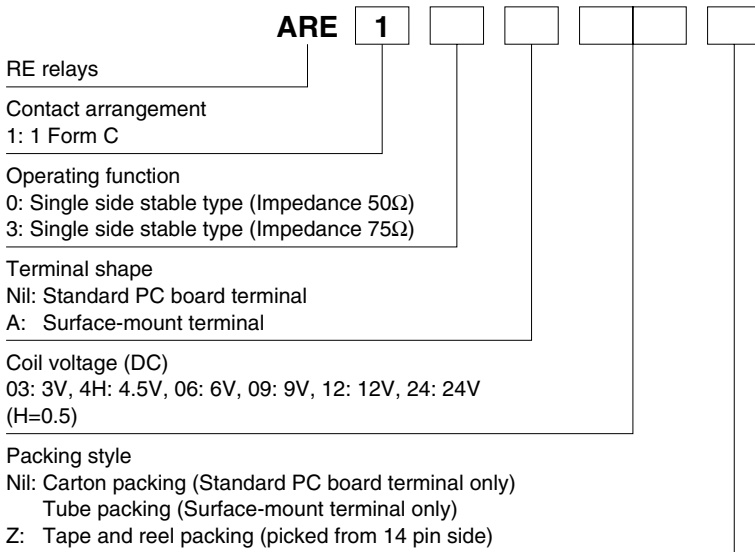

勝特力材料 886-3-5753170
 勝特力电子(上海) 86-21-34970699
 勝特力电子(深圳) 86-755-83298787
[Http://www.100y.com.tw](http://www.100y.com.tw)

TYPES

1. Standard PC board terminal

Nominal coil voltage	Part No.	
	Single side stable type (Impedance 50Ω)	Single side stable type (Impedance 75Ω)
3 V DC	ARE1003	ARE1303
4.5V DC	ARE104H	ARE134H
6 V DC	ARE1006	ARE1306
9 V DC	ARE1009	ARE1309
12 V DC	ARE1012	ARE1312
24 V DC	ARE1024	ARE1324

Standard packing: 50 pcs. in an inner package; 500 pcs. in an outer package

2. Surface-mount terminal

1) Tube package

Nominal coil voltage	Part No.	
	Single side stable type (Impedance 50Ω)	Single side stable type (Impedance 75Ω)
3 V DC	ARE10A03	ARE13A03
4.5V DC	ARE10A4H	ARE13A4H
6 V DC	ARE10A06	ARE13A06
9 V DC	ARE10A09	ARE13A09
12 V DC	ARE10A12	ARE13A12
24 V DC	ARE10A24	ARE13A24

Standard packing: 25 pcs. in an inner package (tube); 200 pcs. in an outer package

2) Tape and reel package

Nominal coil voltage	Part No.	
	Single side stable type (Impedance 50Ω)	Single side stable type (Impedance 75Ω)
3 V DC	ARE10A03Z	ARE13A03Z
4.5V DC	ARE10A4HZ	ARE13A4HZ
6 V DC	ARE10A06Z	ARE13A06Z
9 V DC	ARE10A09Z	ARE13A09Z
12 V DC	ARE10A12Z	ARE13A12Z
24 V DC	ARE10A24Z	ARE13A24Z

Standard packing: 400 pcs. in an inner package (tape and reel); 800 pcs. in an outer package

RATING

1. Coil data

Nominal coil voltage	Pick-up voltage (at 20°C 68°F)	Drop-out voltage (at 20°C 68°F)	Nominal operating current [±10%] (at 20°C 68°F)	Coil resistance [±10%] (at 20°C 68°F)	Nominal operating power	Max. applied voltage (at 70°C 158°F)
3 V DC	75%V or less of nominal voltage (Initial)	10%V or more of nominal voltage (Initial)	66.7mA	45Ω	200mW	110%V of nominal voltage
4.5V DC			44.4mA	101Ω		
6 V DC			33.3mA	180Ω		
9 V DC			22.2mA	405Ω		
12 V DC			16.7mA	720Ω		
24 V DC			8.3mA	2,880Ω		

勝特力材料 886-3-5753170
 勝特力电子(上海) 86-21-34970699
 勝特力电子(深圳) 86-755-83298787
[Http://www.100y.com.tw](http://www.100y.com.tw)

RE (ARE)

2. Specifications

Characteristics	Item	Specifications	
Contact	Arrangement	1 Form C	
	Contact material	Gold plating	
	Initial contact resistance, max.	Max. 100mΩ (By voltage drop 10V AC 10mA)	
Rating	Contact rating	1W (at 2.6 GHz [Impedance 75Ω, V.S.W.R. Max.1.5] [Impedance 50Ω, V.S.W.R. Max.1.7]) 10mA 24V DC (resistive load)	
	Contact carrying power	10W (at 2.6GHz [Impedance 75Ω, V.S.W.R. Max.1.5] [Impedance 50Ω, V.S.W.R. Max.1.7])	
	Max. switching voltage	30V DC	
	Max. switching current	0.5A DC	
	Nominal operating power	200mW	
High frequency characteristics (Initial) (Impedance 75Ω)	V.S.W.R.	Max. 1.2 (to 900MHz), Max. 1.5 (to 2.6GHz)	
	Insertion loss	Max. 0.2dB (to 900MHz), Max. 0.5dB (to 2.6GHz)	
	Isolation	Min. 60dB (to 900MHz), Min. 30dB (to 2.6GHz)	
High frequency characteristics (Initial) (Impedance 50Ω)	V.S.W.R.	Max. 1.3 (to 900MHz), Max. 1.7 (to 2.6GHz)	
	Insertion loss	Max. 0.2dB (to 900MHz), Max. 0.7dB (to 2.6GHz)	
	Isolation	Min. 60dB (to 900MHz), Min. 30dB (to 2.6GHz)	
Electrical characteristics	Insulation resistance (Initial)		Min. 100MΩ (at 500V DC) Measurement at same location as "Initial breakdown voltage" section.
	Breakdown voltage (Initial)	Between open contacts	500 Vrms for 1min. (Detection current: 10mA)
		Between contact and coil	1,000 Vrms for 1min. (Detection current: 10mA)
		Between contact and earth terminal	500 Vrms for 1min. (Detection current: 10mA)
	Temperature rise (at 20°C)		Max. 60°C (By resistive method, nominal voltage applied to the coil: Contact carrying power: 10W, at 2.6GHz, [Impedance 75Ω, V.S.W.R. ≤ 1.5] [Impedance 50Ω, V.S.W.R. ≤ 1.7])
	Operate time (at 20°C)		Max. 10ms (Nominal operating voltage applied to the coil, excluding contact bounce time.)
	Release time (at 20°C)		Max. 5ms (Nominal operating voltage applied to the coil, excluding contact bounce time.) (without diode)
Mechanical characteristics	Shock resistance	Functional	Min. 500 m/s ² {50 G} (Half-wave pulse of sine wave: 11ms; detection time: 10μs.)
		Destructive	Min. 1,000m/s ² {100 G} (Half-wave pulse of sine wave: 6ms.)
	Vibration resistance	Functional	10 to 55 Hz at double amplitude of 3mm (Detection time: 10μs.)
		Destructive	10 to 55 Hz at double amplitude of 5mm
Expected life	Mechanical	Min. 10 ⁶ (at 180 cpm)	
	Electrical	Min. 3×10 ⁵ (1W, 2.6GHz, [Impedance 75Ω, V.S.W.R. ≤ 1.5] [Impedance 50Ω, V.S.W.R. ≤ 1.7]) Min. 3×10 ⁵ (10mA 24V DC (resistive load) (at 20cpm))	
Conditions	Conditions for operation, transport and storage*		Ambient temperature: -40°C to +70°C -40°F to +158°F Humidity: 5 to 85% R.H. (Not freezing and condensing at low temperature)
Unit weight			Approx. 5 g .18 oz

Note: * The upper operation ambient temperature limit is the maximum temperature that can satisfy the coil temperature rise value. Refer to [6] AMBIENT ENVIRONMENT in GENERAL APPLICATION GUIDELINES.

REFERENCE DATA

1-(1). High frequency characteristics (Impedance 50Ω) (Standard PC board terminal)

• V.S.W.R. characteristics

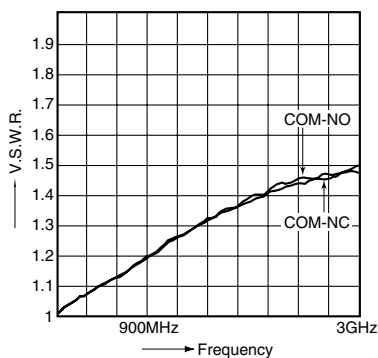

• Insertion loss characteristics

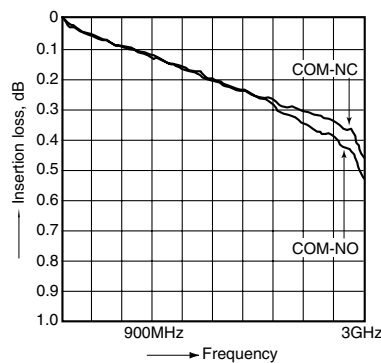

• Isolation characteristics

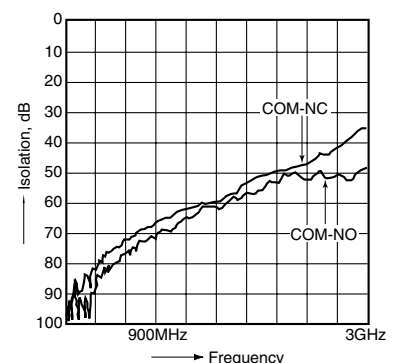

1-(2). High frequency characteristics (Impedance 75Ω) (Standard PC board terminal)

• V.S.W.R. characteristics

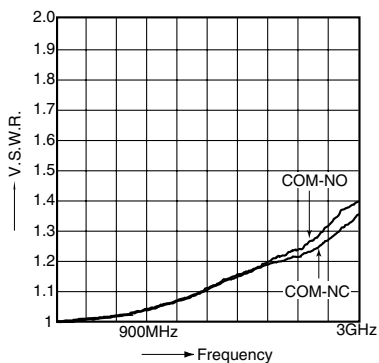

• Insertion loss characteristics

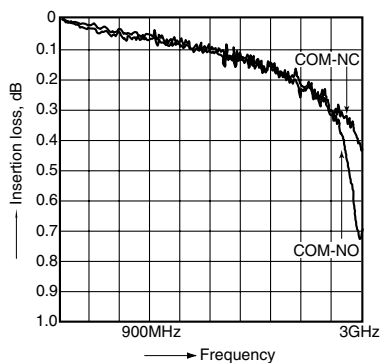

• Isolation characteristics

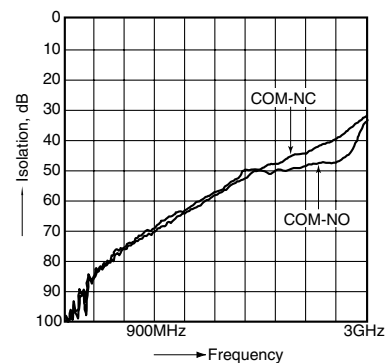

DIMENSIONS (mm inch)

The CAD data of the products with a **CAD Data** mark can be downloaded from: <http://industrial.panasonic.com/ac/e/>

1. Standard PC board terminal (50Ω, 75Ω type)

CAD Data

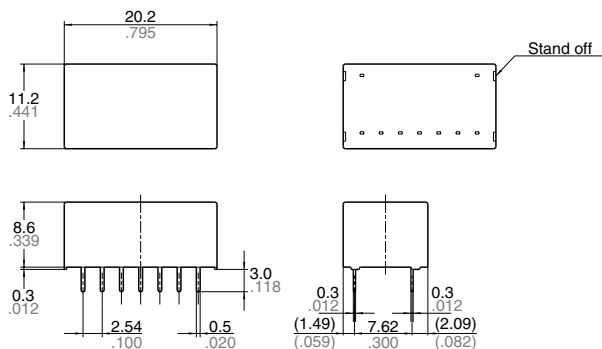

General tolerance: $\pm 0.3 \pm 0.012$

Schematic (Bottom view)

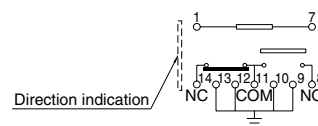

(Deenergized condition)

2. Surface mount terminal

• 50Ω type

CAD Data

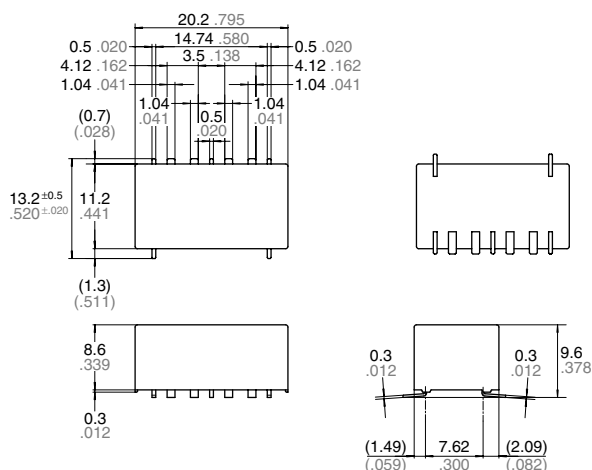

General tolerance: $\pm 0.3 \pm 0.012$

Schematic (Top view)

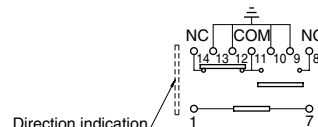

(Deenergized condition)

勝特力材料 886-3-5753170
 勝特力电子(上海) 86-21-34970699
 勝特力电子(深圳) 86-755-83298787
[Http://www.100y.com.tw](http://www.100y.com.tw)

RE (ARE)

• 75Ω type

CAD Data

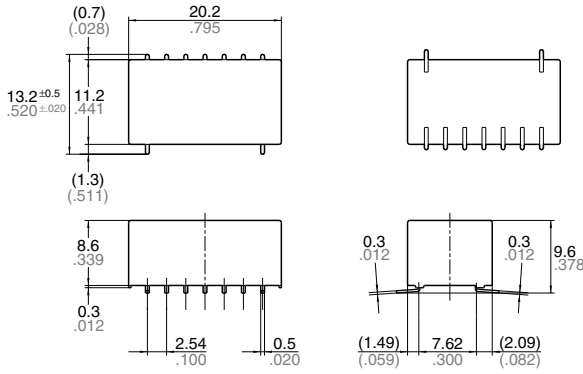

General tolerance: $\pm 0.3 \pm 0.012$

Schematic (Top view)

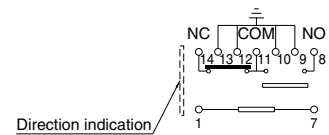

(Deenergized condition)

勝特力材料 886-3-5753170
 胜特力电子(上海) 86-21-34970699
 胜特力电子(深圳) 86-755-83298787
[Http://www.100y.com.tw](http://www.100y.com.tw)

Note: Please consult us regarding recommended PC board patterns.

NOTES

1. Coil operating power

Pure DC current should be applied to the coil. The wave form should be rectangular. If it includes ripple, the ripple factor should be less than 5%. However, check it with the actual circuit since the characteristics may be slightly different.

2. Cleaning

For automatic cleaning, the boiling method is recommended. Avoid ultrasonic cleaning which subjects the relays to high frequency vibrations, which may cause the contacts to stick. It is recommended that alcoholic solvents be used.

3. Soldering

(Standard PC board terminal)

- The manual soldering shall be performed under following condition.
Max. 260°C 500°F 10s
Max. 350°C 662°F 3s

The affect of the PCB on the relay will differ depending on the type of PCB used. Please verify the type of PCB to be used.

Preheat according to the following conditions.

Temperature	120°C 248°F or less
Time	Within 2 minute

Soldering should be done at 260±5°C 500±9°F within 6 s.

- In case of automatic soldering, the following conditions should be observed (Surface-mount terminal)

(1) Position of measuring temperature

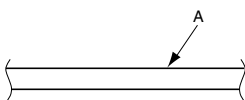

A: Surface of PC board where relay is mounted.

(2) IR (infrared reflow) soldering method

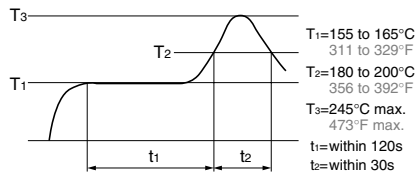

Temperature rise of relay itself may vary according to the mounting level or the heating method of reflow equipment. Therefore, please set the temperature of soldering portion of relay terminal and the top surface of the relay case not to exceed the above mentioned soldering condition.

It is recommended to check the temperature rise of each portion under actual mounting condition before use.

4. Packing style

1) Tape dimensions

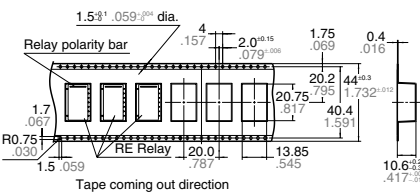

2) Dimensions of plastic reel

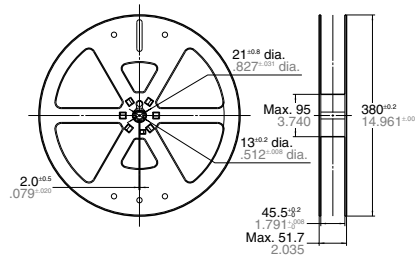

5. Conditions for operation, transport and storage conditions

- Ambient temperature, humidity, and atmospheric pressure during usage, transport, and storage of the relay:

(1) Temperature:

-40 to +70°C -40 to +158°F

(2) Humidity: 5 to 85% RH

(Avoid freezing and condensation.)

The humidity range varies with the temperature. Use within the range indicated in the graph below.

(3) Atmospheric pressure: 86 to 106 kPa

Temperature and humidity range for usage, transport, and storage:

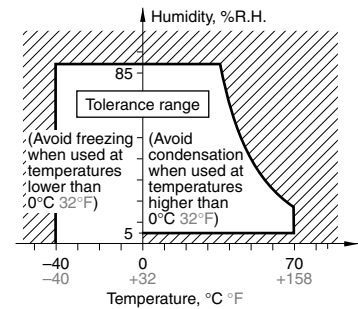

2) Condensation

Condensation forms when there is a sudden change in temperature under high temperature and high humidity conditions. Condensation will cause deterioration of the relay insulation.

3) Freezing

Condensation or other moisture may freeze on the relay when the temperature is lower than 0°C 32°F. This causes problems such as sticking of movable parts or operational time lags.

4) Low temperature, low humidity environments

The plastic becomes brittle if the relay is exposed to a low temperature, low humidity environment for long periods of time.

For general cautions for use, please refer to the "General Application Guidelines".